

Electrical Characteristics										
Frequency	Hz	50				60				
Voltage (series star)	V	380	400	415	440	415	440	460	480	
Rated power class H	kVA	200	200	200	190	230	240	240	240	
	kW	160	160	160	152	184	192	192	192	
Rated power class F	kVA	185	185	185	175	210	220	220	220	
	kW	148	148	148	140	168	176	176	176	
Regulation with UVR6		±1 % with any power factor and speed variations between -5% +30%								
Insulation class		H								
Execution		Brushless								
Stator winding		12 ends								
Rotor		with damping cage								
Efficiencies class H	4/4	%	92,6	92,7	92,4	92,2	93,1	93,6	93,7	93,8
(see graph. for details)	3/4	%	92,6	92,9	92,8	92,5	93,4	93,6	93,8	94
	2/4	%	91,6	91,7	91,7	91,5	92,5	92,6	92,7	92,8
	1/4	%	90,1	89,9	89,7	89,5	90,6	90,6	90,6	90,4
Reactances (f. l.cl. F)	Xd	%	221,6	200	185,8	157,0	256,4	238,0	217,8	200
	Xd'	%	12,2	11,0	10,2	8,6	14,1	13,1	12,0	11,0
	Xd''	%	6,5	5,9	5,5	4,6	7,6	7,0	6,4	5,9
	Xq	%	121,9	110	102,2	86,4	141,0	130,9	119,8	110
	Xq'	%	121,9	110	102,2	86,4	141,0	130,9	119,8	110
	Xq''	%	23,8	21,5	20,0	16,9	27,6	25,6	23,4	21,5
	X ₂	%	15,8	14,3	13,3	11,2	18,3	17,0	15,6	14,3
	X ₀	%	2,8	2,5	2,3	2,0	3,2	3,0	2,7	2,5
Short Circuit Ratio	Kcc		0,43	0,46	0,64	1,02	0,32	0,39	0,43	0,46
Time Constants	Td'	sec.	0,078							
	Td''	sec.	0,012							
	Tdo'	sec.	0,90							
	Tα	sec.	0,016							
Short Circuit Current Capacity		%	>300				>350			
Excitation at no load	Amp.		0,5	0,7	0,9	1,2	0,3	0,35	0,45	0,65
Excitation at full load	Amp.		2,9	3	3,2	3,4	2,4	2,6	2,8	2,9
Overload (long-term)		%	1 hour in a 6 hours period 110% rated load							
Overload per 20 sec.		%	300							
Stator Winding Resistance (20°C)		Ω	0,0105							
Rotor Winding Resistance (20°C)		Ω	4,133							
Exciter Resistance (20 °C)		Ω	Rotor : 0,685				Stator : 15,28			
Heat dissipation at f.l.cl.H	W		12786	12600	13160	12859	13637	13128	12909	12691
Telephone Interference			FHT < 2%				TIF < 40			
Radio interference			EN50081-1, EN50082-1, VDE0875K. For others standards apply to factory							
Waveform Distors.(THD) at f. load	LL/LN %		2,7 / 2,6							
Waveform Distors.(THD) at no load	LL/LN %		3 / 2,9							
Mechanical characteristics										
Protection			IP 21 (other protection on request)							
DE bearing			6318.2RS							
NDE bearing			6314.2RS							
Weight of wound stator assembly	kg		174							
Weight of wound rotor assembly	kg		113							
Weight of complete generator	kg		560							
Maximun overspeed	rpm		2250							
Unbalanced magnetic pull at f.l.cl.F	kN/mm		5,2							
Cooling air requirement	m ³ /min		32				39			
Inertia Constant (H)	sec.		0,116				0,140			
Noise level at 1m/7m	dB(A)		82 / 69				86 / 73			

All technical data are to be considered as a reference and they can be modified without any notice

This document is a propriety of Mecc Alte S.p.a..All rights reserved.

50 Hz

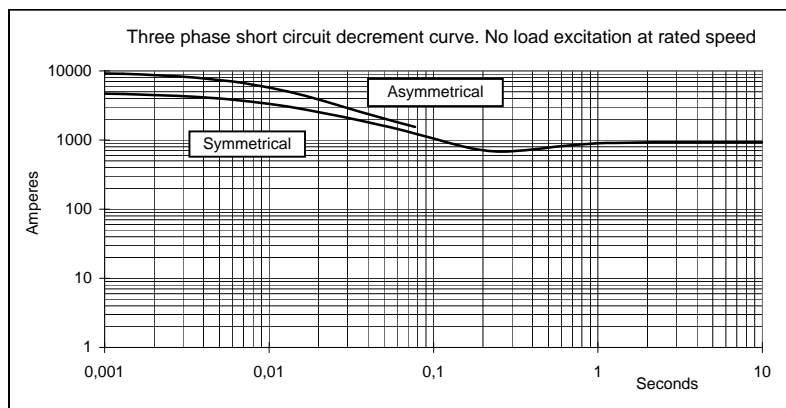
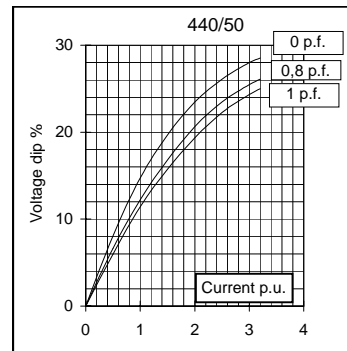
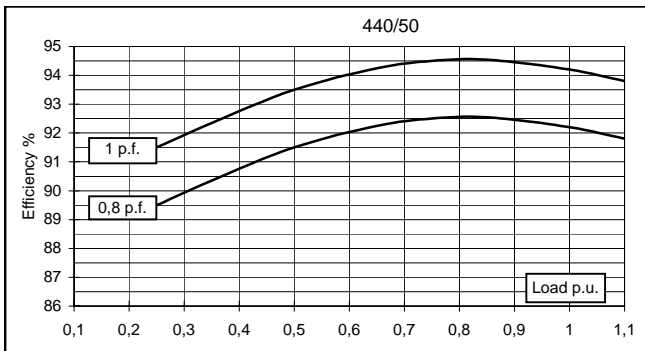
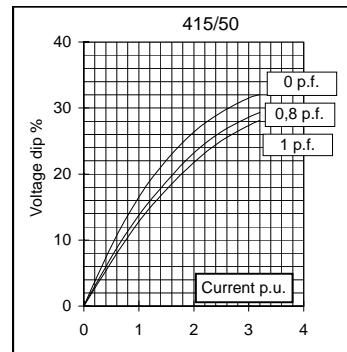
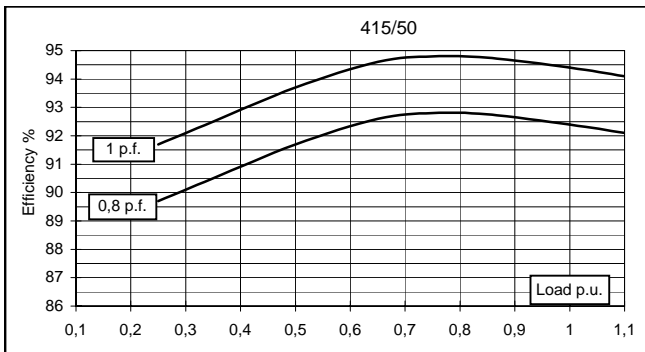
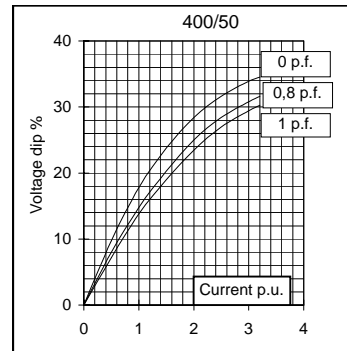
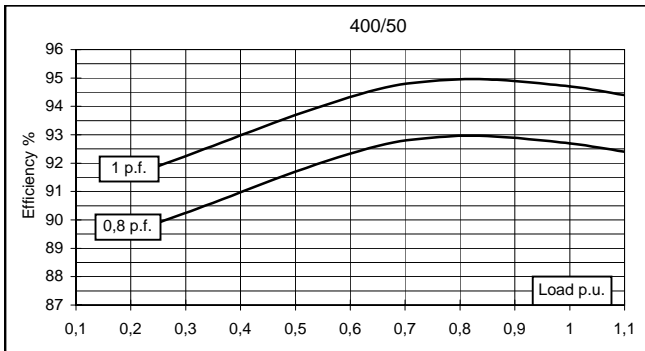
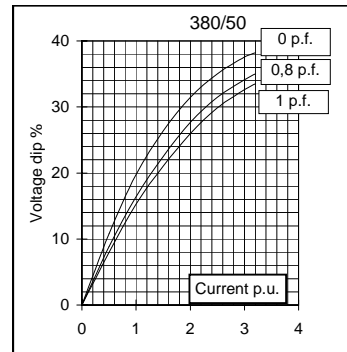
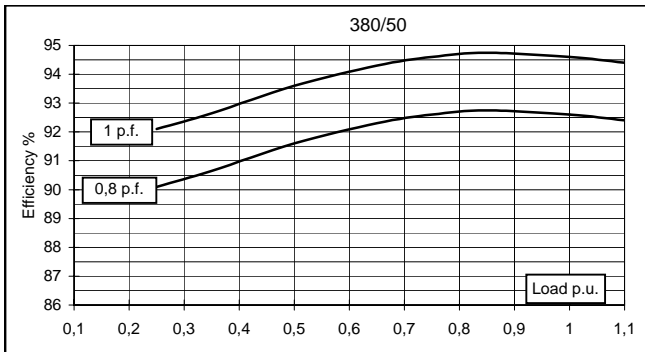

60 Hz

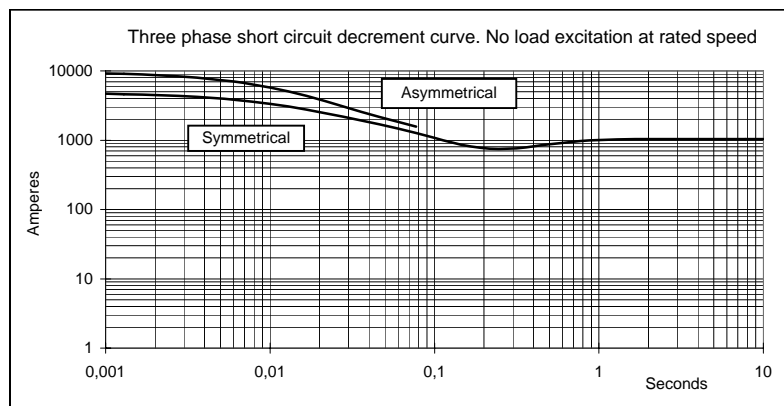
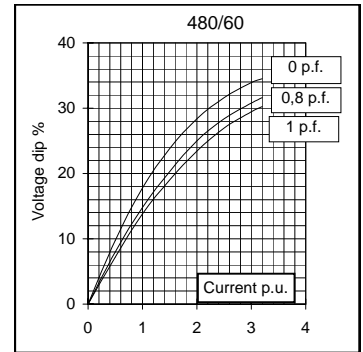
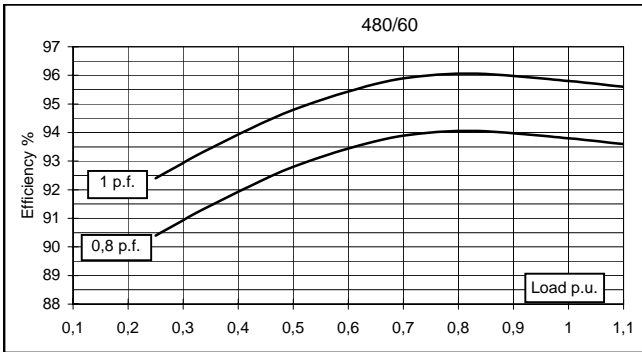
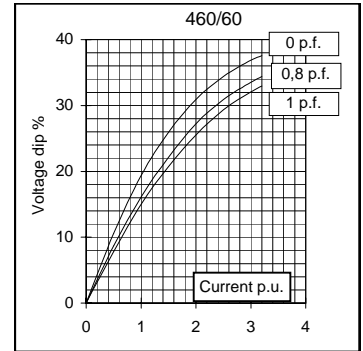
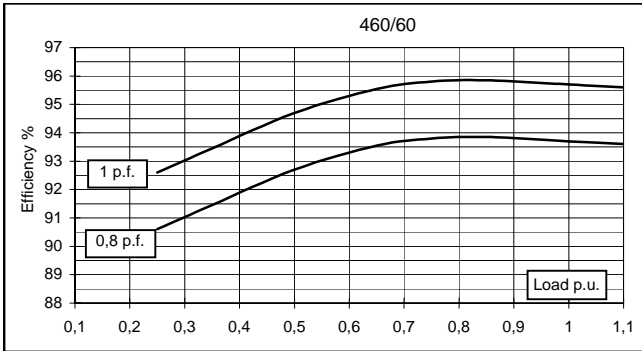
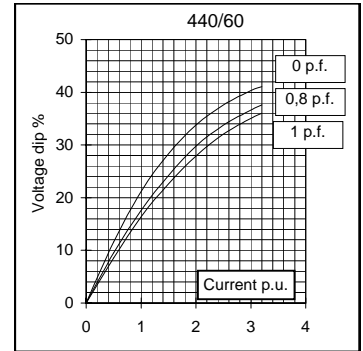
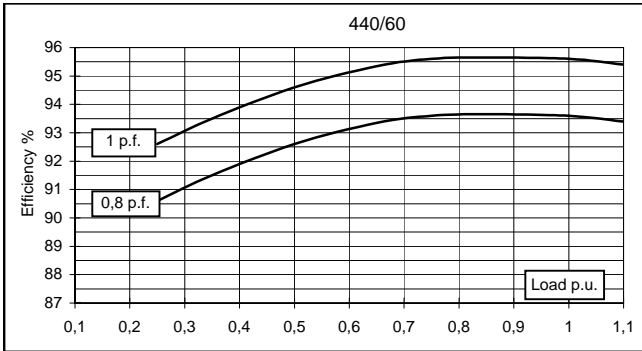
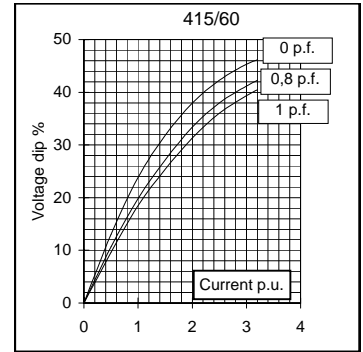
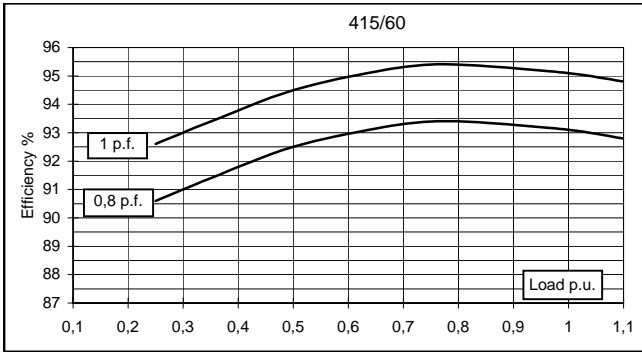

TWO BEARING MOMENTS OF INERTIA

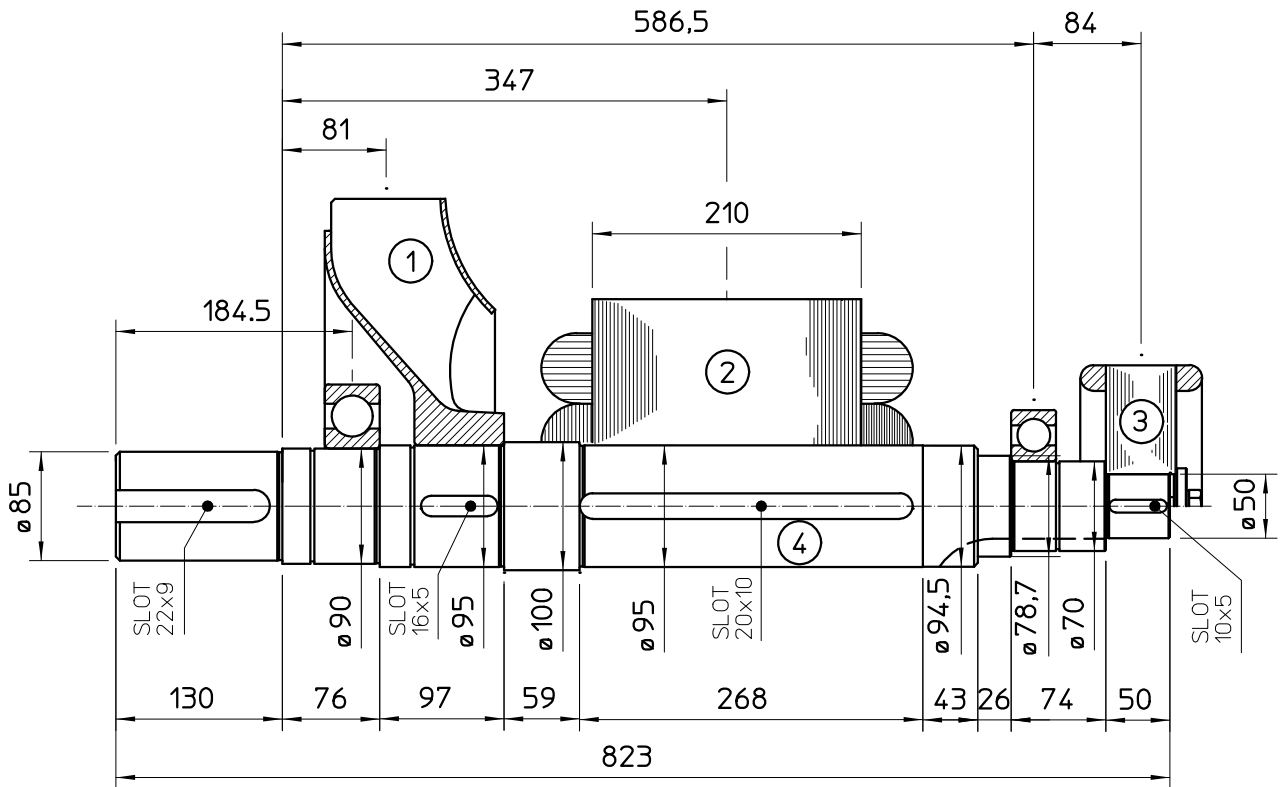

COMPONENT	WEIGHT kg	J kgm^2
1 FAN	6,1	0,1887
2 MAIN ROTOR	113	1,5641
3 EX. ROTOR	14,5	0,0874
4 SHAFT	38,5	0,0397
TOTAL	172,1	1,8799

TWO BEARING DIMENSIONS

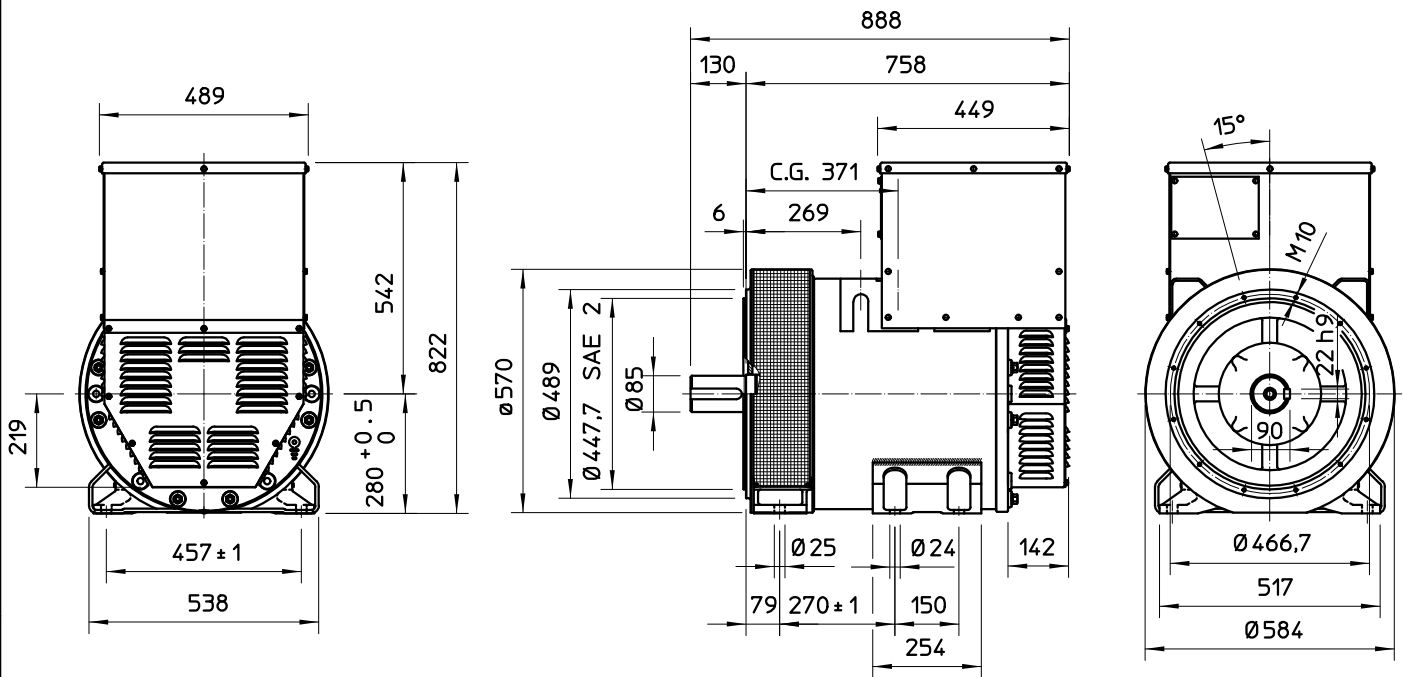

SINGLE BEARING MOMENTS OF INERTIA

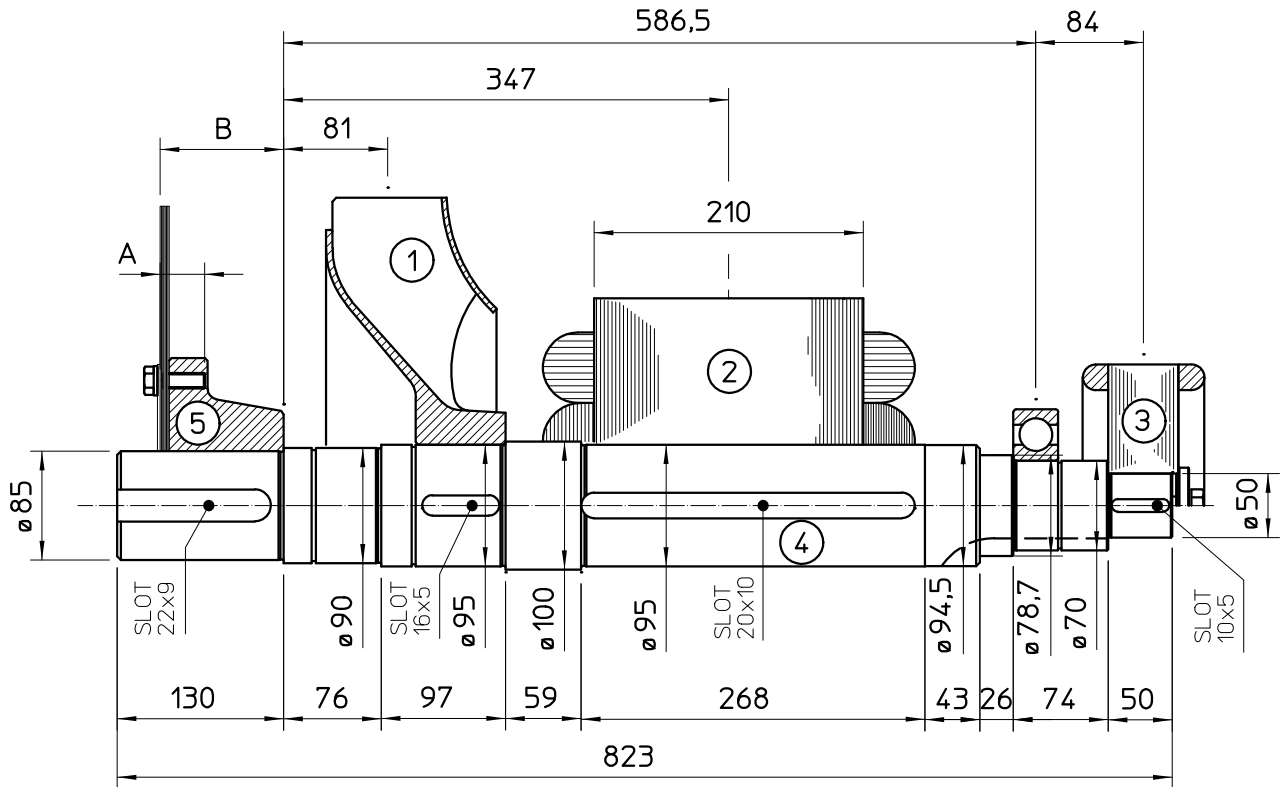

COMPONENT	WEIGHT kg	J kgm ²
1 FAN	6,1	0,1887
2 MAIN ROTOR	113	1,5641
3 EX. ROTOR	14,5	0,0874
4 SHAFT	38,5	0,0397
TOTAL	172,1	1,8799

SAE No	SHAFTS COUPLING FLEX PLATE			
	A	B	WEIGHT kg	J kgm ²
5				
11,5	41,1	110,4	20,5	0,174
14	34,7	96,4	23,5	0,275

SINGLE BEARING DIMENSIONS

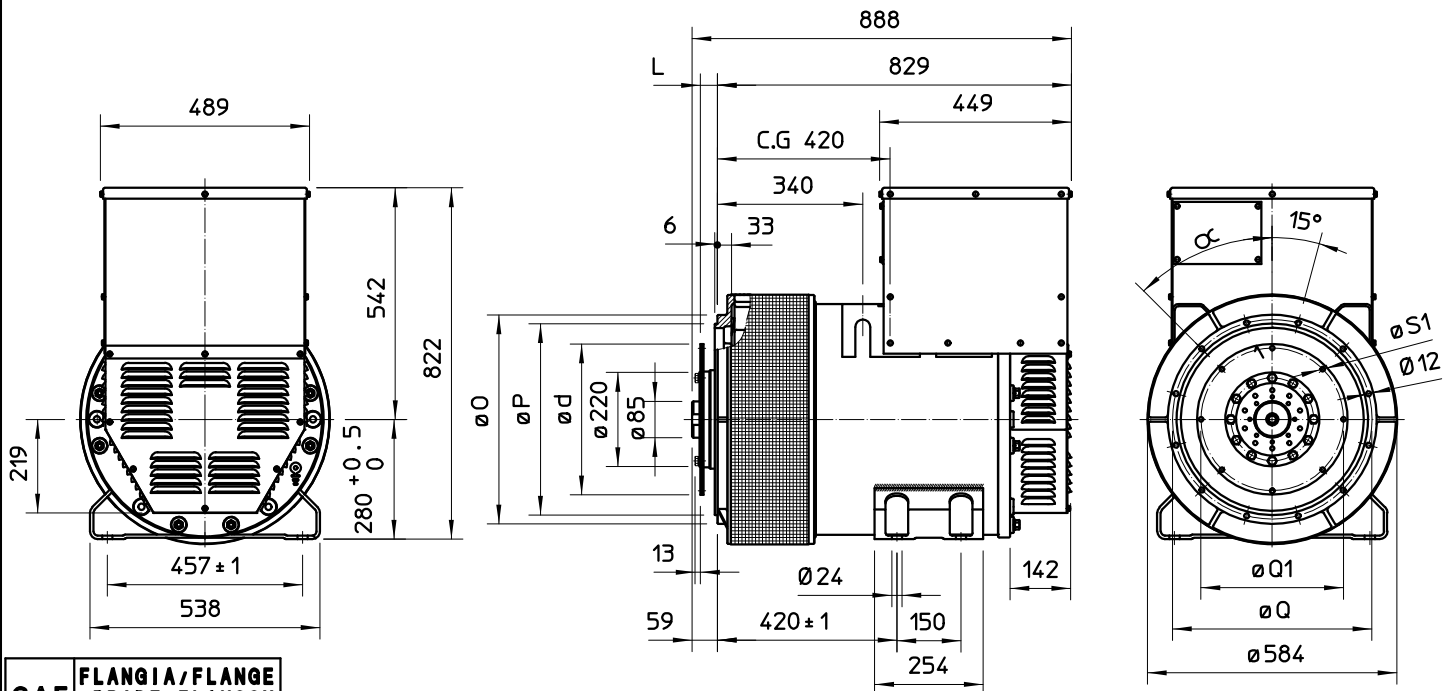

SAE N.	FLANGIA/FLANGE BRIDE/FLANSCH		
	O	P	Q
3	451	409,6	428,6
2	489	447,7	466,7
1	552	511,2	530,2
1/2	648	584,2	619,1

SAE N.	GIUNTI A DISCHI DISC COUPLING DISQUE DE MONOPALIER SCHEIBENKUPPLUNG					
	L	d	Q1	n. fori	S1	α1
11 1/2	39,6	352,42	333,37	8	11	45°
14	25,4	466,72	438,15	8	14	45°

C.G = GRAVITY CENTER